

Composite dry sliding bushings, metric dimensions

Principal dimensions			Basic load ratings		Mass	Designation
d	D	B	dynamic C	static C0		
mm			kN		kg	-
<b>32</b>	36	30	75	232	0,048	PCM 323630 E

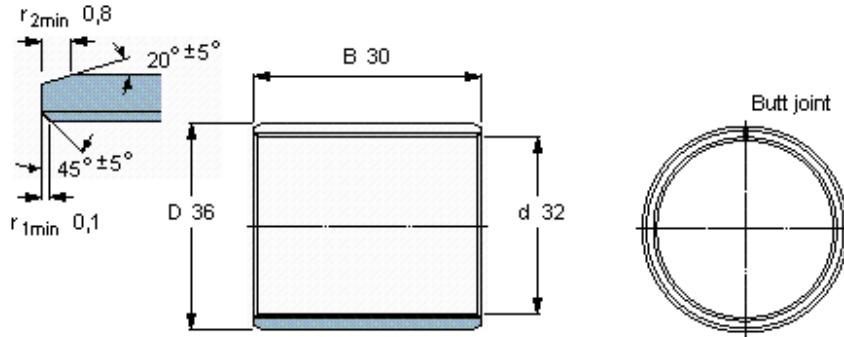

**Specific load factor**  
**Material constant**

K 80  
K<sub>M</sub> 480